

PRESTAN[®] MCR[®] MEDICAL[®]

Ultralite[®] 4

with CPR Feedback

-User Guide-

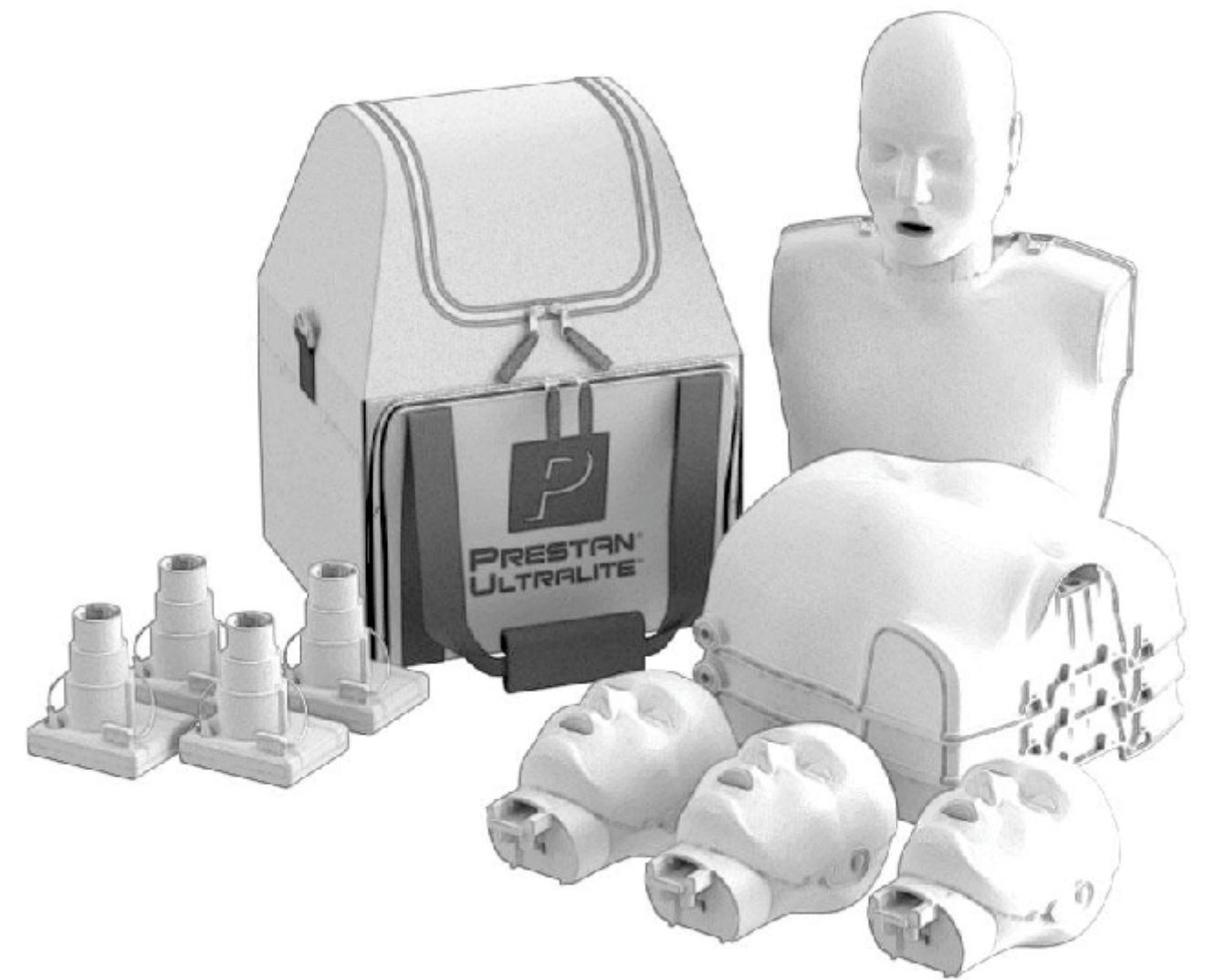

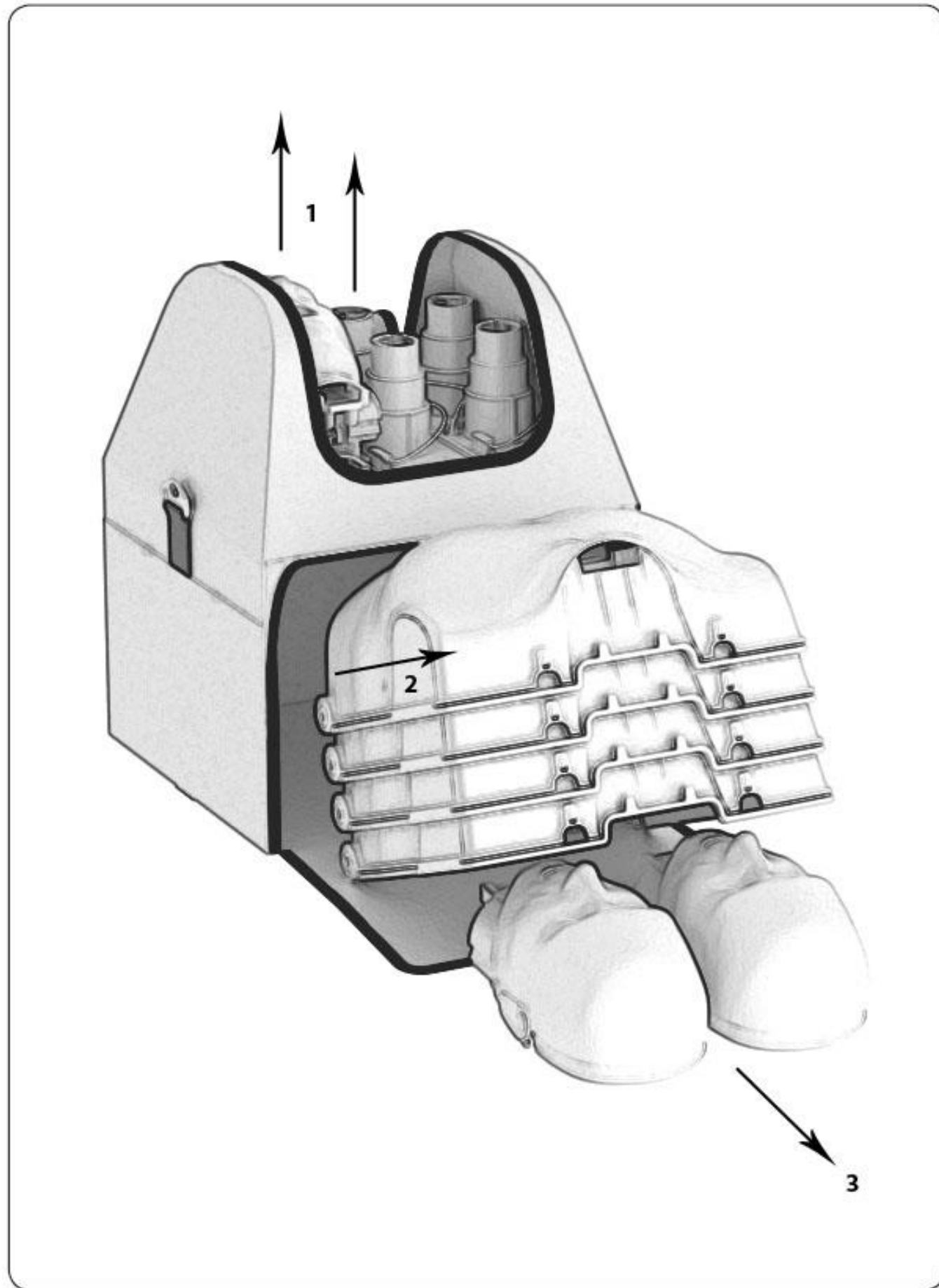

PRESTAN PRODUCTS THREE YEAR LIMITED WARRANTY

1. **WARRANTY COVERAGE:** Prestan offers a LIMITED WARRANTY against any defects in workmanship or materials under normal use with respect to its PRESTAN TRAINING MANIKIN.
2. **WARRANTY PERIOD:** Prestan warrants the PRESTAN TRAINING MANIKIN for three (3) years from the date of purchase. Any component of the PRESTAN TRAINING MANIKIN which proves defective within thirty-six (36) months from the date of purchase will be repaired or replaced, at Prestan's option, free of charge to the owner. The owner is responsible for shipping and handling fees to the place which Prestan designates.
3. **WARRANTOR'S RESPONSIBILITIES:** Prestan will repair or replace (at Prestan's option) a defective warranted component subject to the provisions of Section 2 without charge except for transportation costs. OWNER'S SOLE AND EXCLUSIVE REMEDY AGAINST PRESTAN SHALL BE FOR THE REPAIR OR REPLACEMENT OF DEFECTIVE GOODS AS PROVIDED HEREIN. Repair or replacement of any component of any PRESTAN TRAINING MANIKIN does not extend this limited warranty or begin a new limited warranty period.
4. **CIRCUMSTANCE NEGATING WARRANTY AND OTHER LIMITATIONS:**
 - A. Prestan reserves the right to refuse warranty service or replacement when product failure is due to misuse, mishandling, misapplication, accident, neglect, improper installation, modification, use of unauthorized parts or attachments, adjustments or repair performed by anyone other than Prestan or its authorized agent, or any causes other than defective workmanship or material.
 - B. This limited warranty does not cover abrasion, abnormal use, damage caused by mishandling, neglect or unauthorized modification. This warranty is void if the PRESTAN TRAINING MANIKIN is structurally altered.
 - C. Owner must provide proof of the date of purchase, place of purchase and the purchase price in order to obtain service under this limited warranty.
 - D. Prestan makes no warranty other than as contained herein. No agent, representative, dealer or employee of Prestan has the authority to alter the obligations or limitations of this limited warranty.
5. **LIMITATIONS OF IMPLIED WARRANTIES AND DAMAGES:**
 - A. Any and all implied warranties on the PRESTAN TRAINING MANIKIN, INCLUDING ANY IMPLIED WARRANTY OF MERCHANTABILITY OR FITNESS FOR A PARTICULAR PURPOSE, SHALL NOT EXCEED IN DURATION THE RESPECTIVE TERMS OF THIS LIMITED WARRANTY WHICH BEGINS WITH THE DATE OF PURCHASE. Some states do not allow limitations on how long an implied warranty lasts, so the above limitation may not apply to you.
 - B. PRESTAN SHALL NOT BE LIABLE FOR INCIDENTAL OR CONSEQUENTIAL DAMAGES ARISING OUT OF THE USE OF THE PRESTAN TRAINING MANIKIN OR THE BREACH OF THIS OR ANY OTHER EXPRESSED OR IMPLIED WARRANTY. Some states do not allow the exclusion or limitation of incidental or consequential damages, so the above limitation or exclusion may not apply to you. Any and all damages awarded for any breach of this limited warranty shall be limited to the amount of the purchase price.
6. **WARRANTY SERVICE:** To obtain warranty service or information, contact Prestan Products, /01 Beta Drive, Suite 3, Mayfield Village, Ohio 44143 — or call Prestan toll free at 1-800-434-7989
7. **RIGHTS UNDER STATE LAW:** This warranty gives you specific legal rights and you may have other rights which vary from state to state.



PRESTAN® Ultralite® Manikins with CPR Feedback

THANK YOU for buying the Prestan Ultralite Manikins with CPR Feedback, # PP-ULM-400M-MS.

CONTENTS:

- Four (4) Manikin Torsos
- Four (4) Manikin Head Faces
- Four (4) Manikin Head Backs
- Four (4) CPR Feedback Pistons (2 AA Batteries required, not included)
- One (1) Nylon Carrying Case with Detachable Strap
- Fifty (50) Ultralite Face-Shield/Lung-Bags

CARE AND CLEANING:

- When not in use, the components should be stored in the carrying case and in a cool, dry place.
- Ultralite Manikins may be cleaned in a variety of ways. A non-abrasive cleaner is recommended
 - They can be wiped down with a Clorox® or Lysol® disinfecting wipe.
 - Cleaned with a mixture of soap and water.
 - Sprayed or wiped with common household cleaners such as Formula 409®, Windex® or Vim®.
- The face may also be sanitized with alcohol, Clorox® or Lysol® wipes. Between student uses (and prior to applying the face shield), the instructor (or student) may clean the faces with a sanitizing wipe as an extra measure of protection.
- Students may be provided with an individual face shield (sold separately) which may be placed over the Face-Shield/Lung-Bag. This allows multiple students to use one Face-Shield/Lung-Bag during a session.

Order through your Prestan Authorized Distributor:

Ultralite Manikins Face Shields, 50-count	#PP-UFS-50
Ultralite Manikins Face-Shield/Lung-Bags, 10-count	#PP-ULB-10
Ultralite Manikins Face-Shield/Lung-Bags, 50-count	#PP-ULB-50

TROUBLESHOOTING:

- If you cannot get the chest to rise when you blow into the face shield lung bag:
 - Check to make sure that the head is tilted back to create an open airway.
 - Check the lung bag itself. Ensure that it is properly positioned over the compression plate, not twisted and is lying flat.
 - Check the face shield. Ensure that it is attached to the 'buttons' on the side of the manikin head and that it is flat against the face of the manikin.
 - Check the bag to ensure that it has not been torn.
- If the chest does not compress and/or it seems the piston is binding:
 - Ensure proper hand placement - check horizontal hand placement and adjust to center in between the nipples.



PRESTAN



ASSEMBLE

Ultralite® Manikins with CPR Feedback

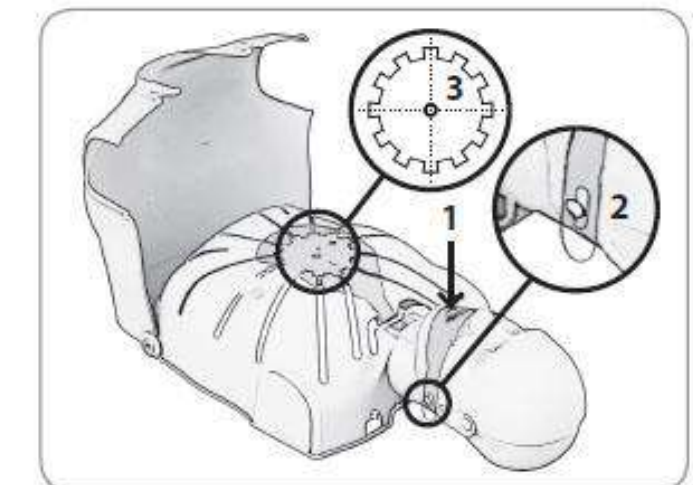
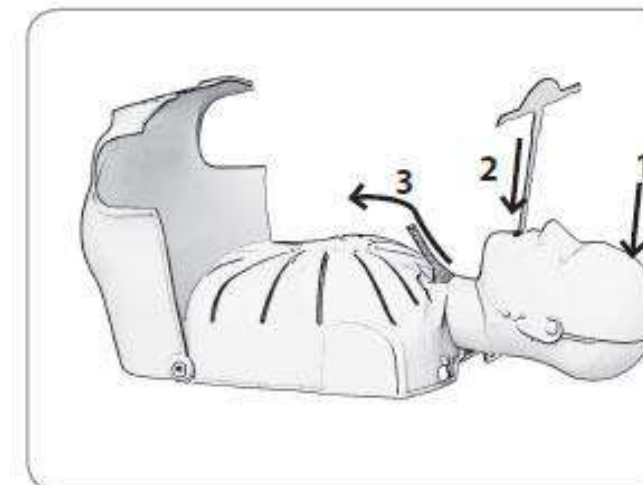
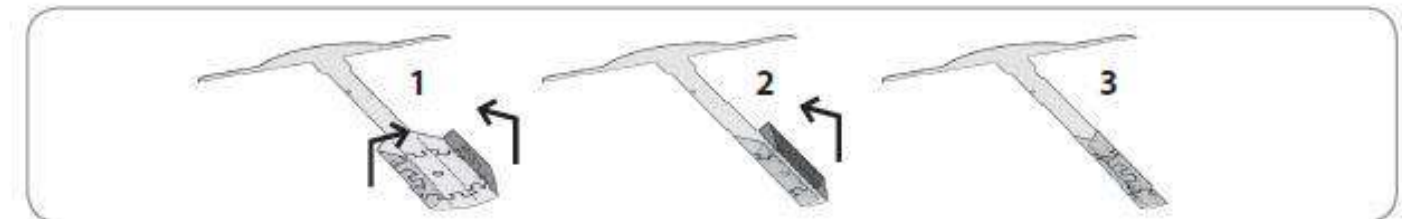
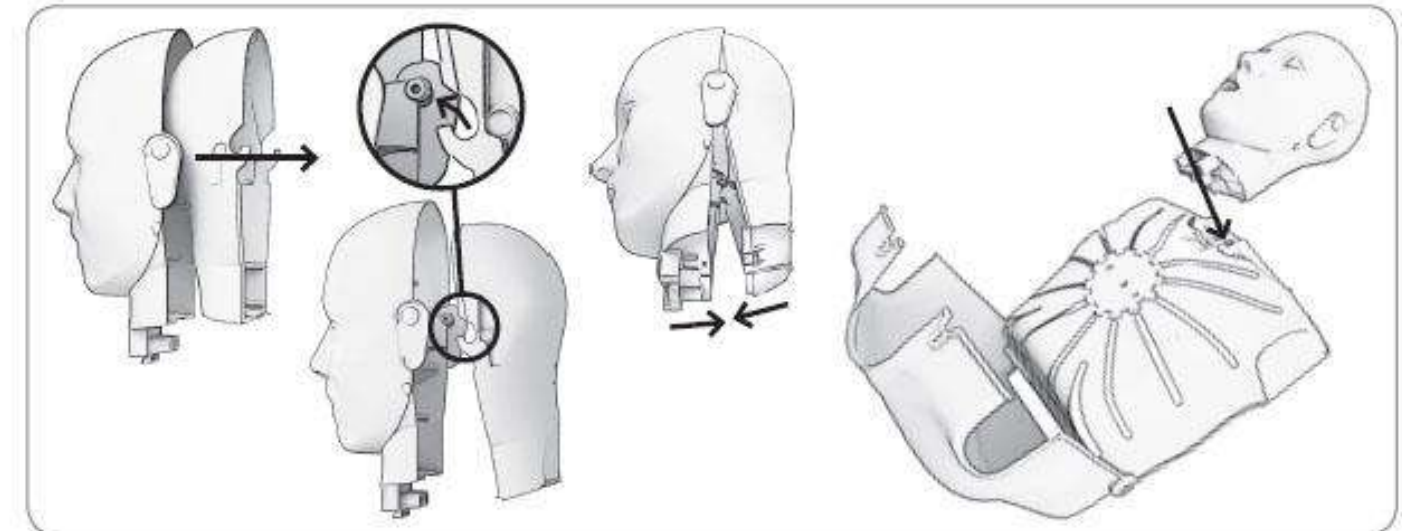
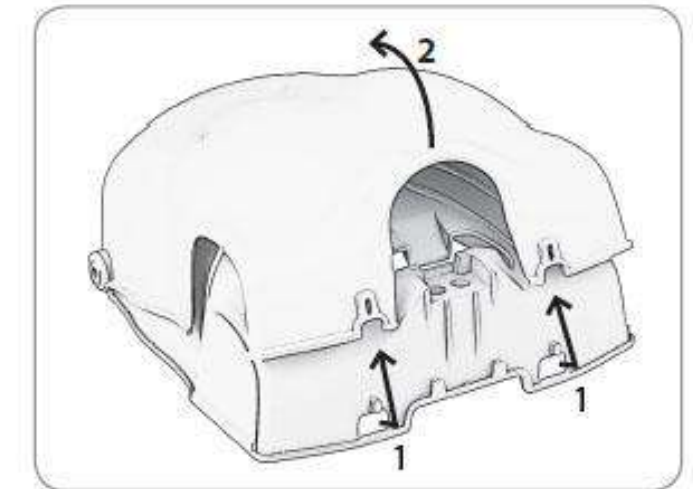
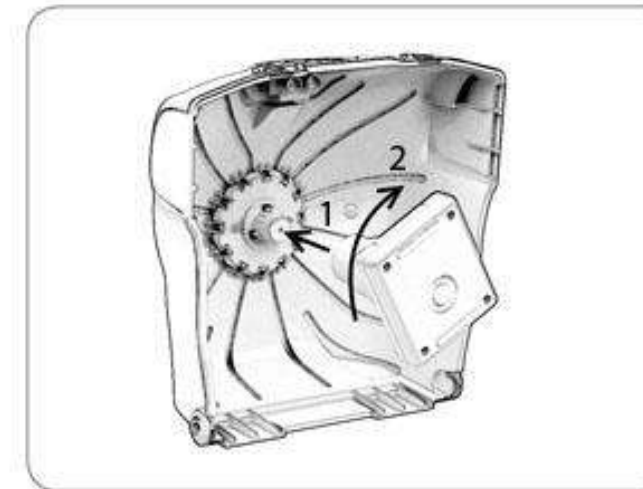

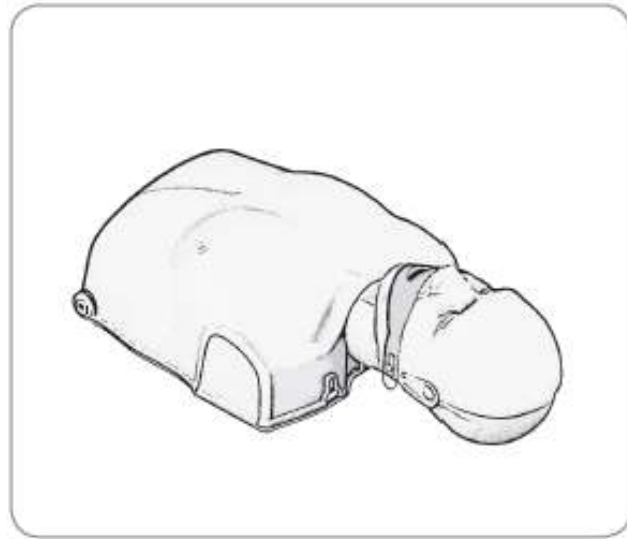
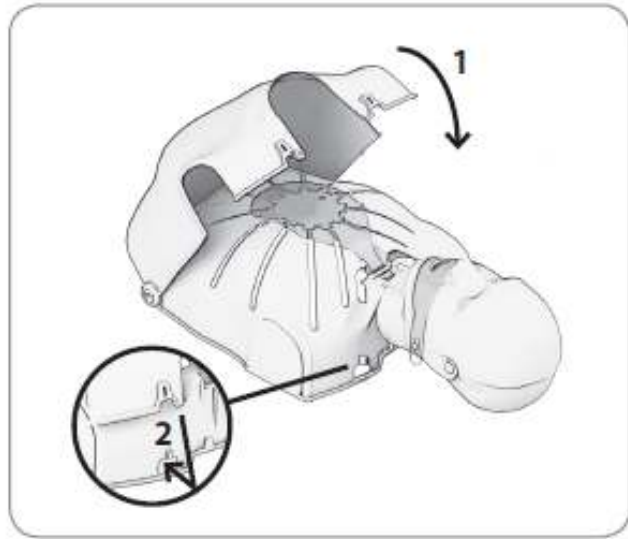

DISASSEMBLE

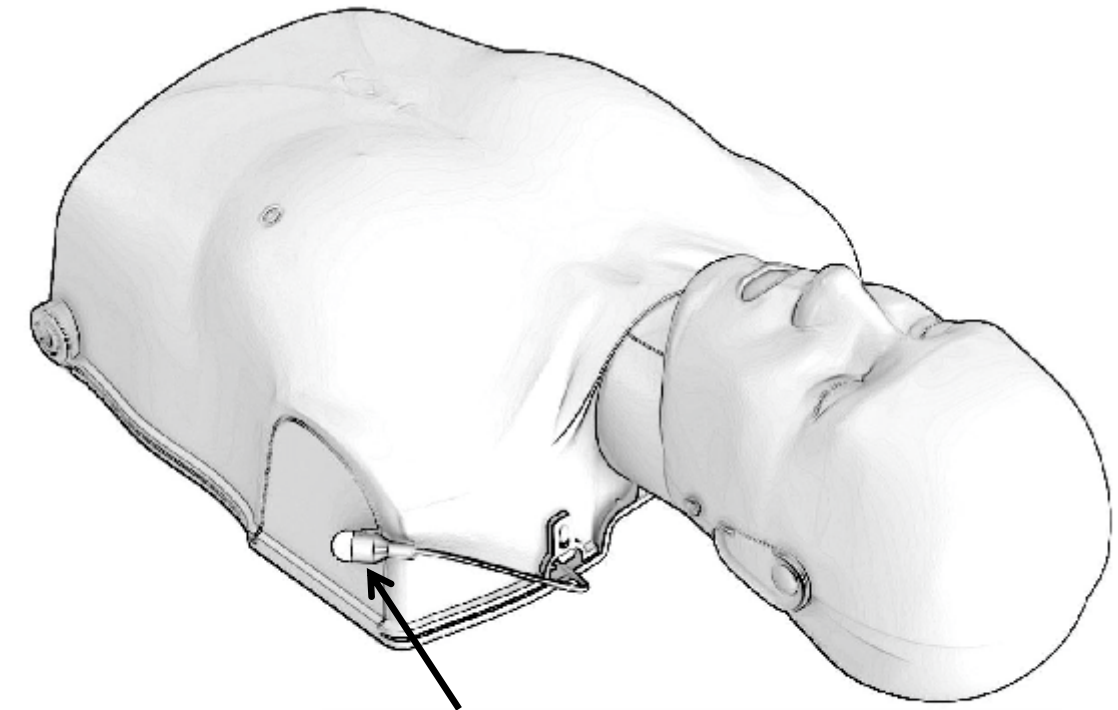
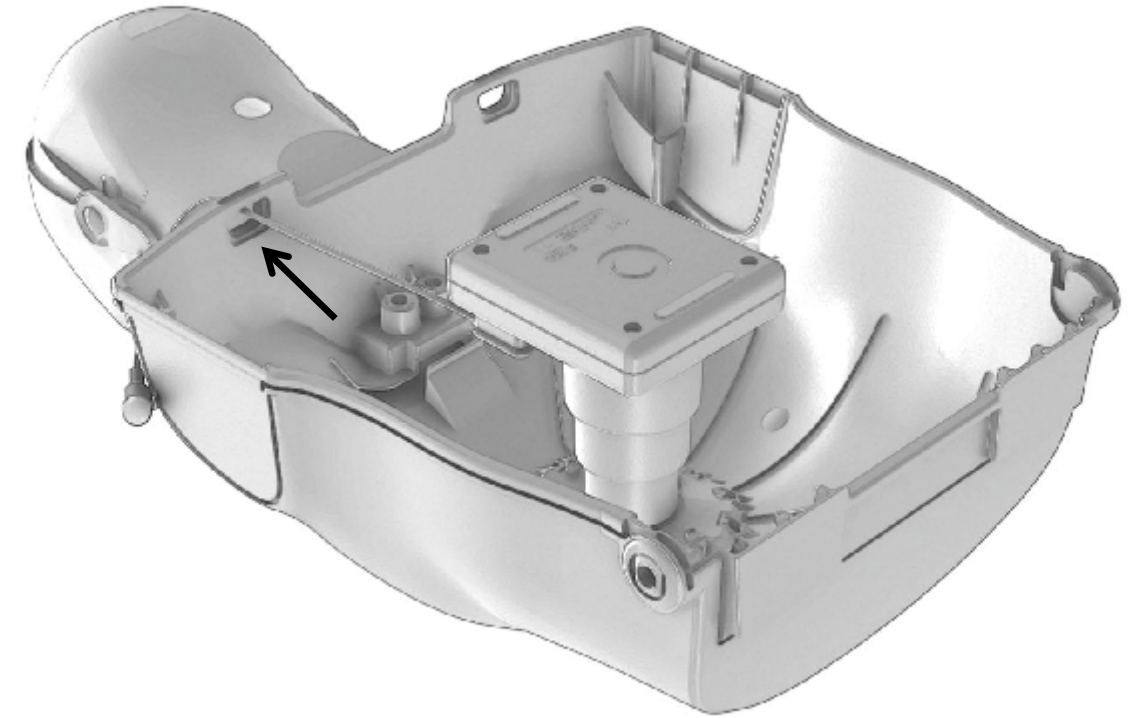
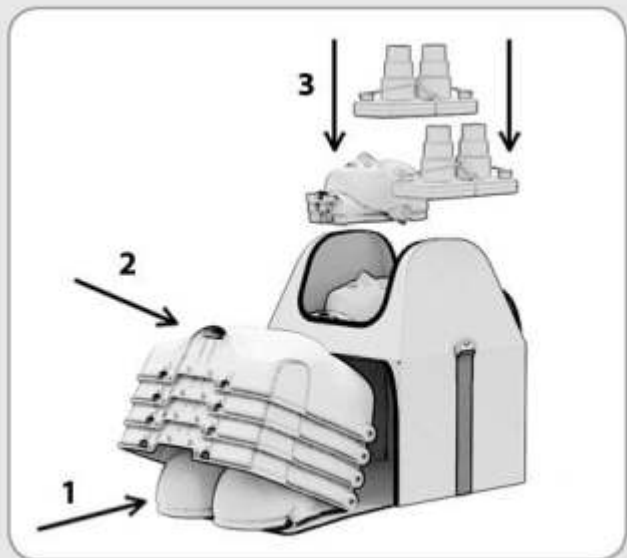
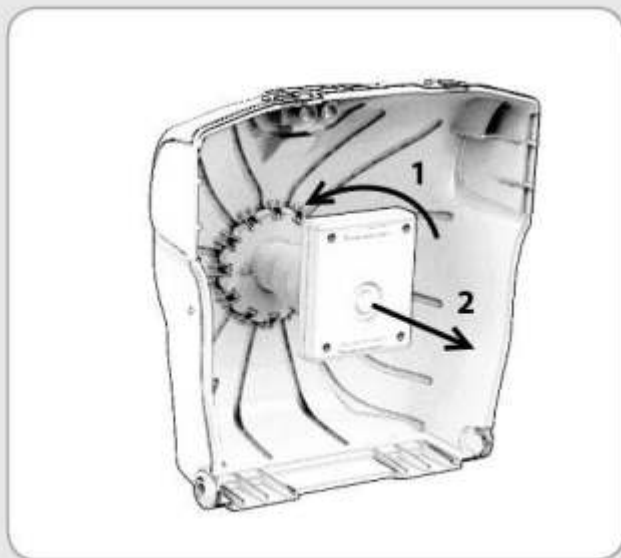
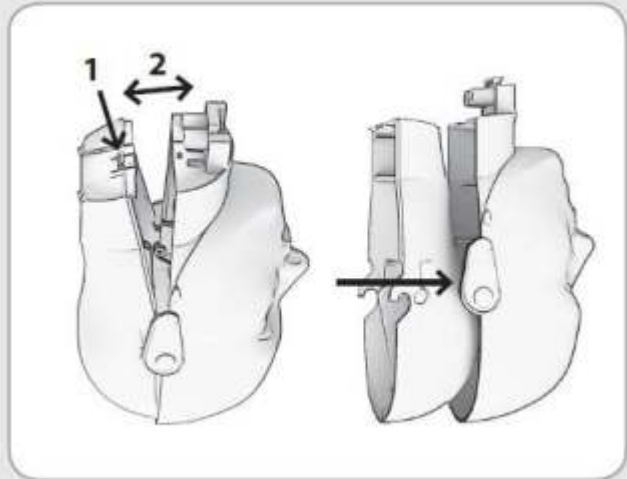
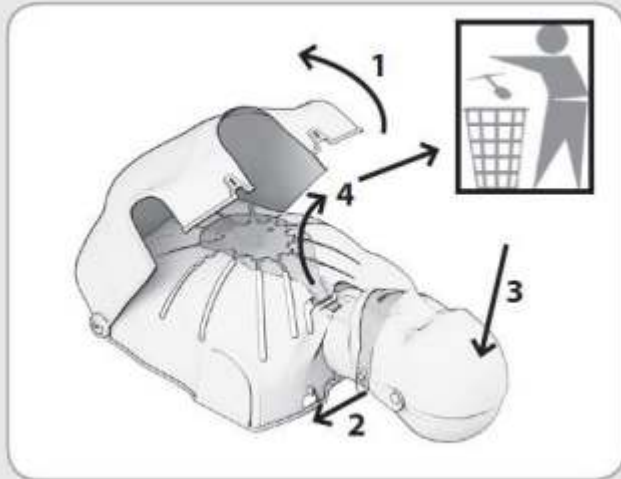

- Solid RED Light indicates under 100 CPM
- Solid GREEN Light indicates 100-120 CPM (As recommended in 2015 AHA and ARC Guidelines)
- Flashing RED Light indicates more than 120 CPM

(CPM: Compressions per minute)